

ENGINEERING GRAPHICS (Code No. 046)

CLASS XI-XII (2024-25)

Study of engineering graphics is defined as the set of graphic communication techniques used to convey the ideas, designs, concepts and information using proper standards. Since ages, professionals like Architects, Draftsmen, Surveyors, and even technocrats have been extensively using concepts and ideas of Engineering Graphics. The subject of 'Engineering Graphics' is an indispensable tool for all the branches of Engineering. This is necessary for the design, construction or analysis of machines, structures, and various systems even digitally. This subject is also useful for various designers like prototype designer, product designer, tool & die designer, apparel designer, footwear designer and interior designer. It is expected that the knowledge gained through the study of different topics and the skills acquired through the prescribed practical work will make the learners to meet the challenges of academic, professional courses and practical applications like design and development of vehicles, industrial products, aircrafts, dental implant fixtures, surgical planning of knee replacement etc. after studying the subject at Senior Secondary Stage.

Objectives:

The study of the subject of Engineering Graphics at Senior School Level aims at helping the learner to:

- Develop clear concept and perception of different objects.

- Reinforcing the related mathematical concepts.

- Develop a clear understanding of plane geometry, solid geometry, and machine drawing to apply the same in relevant practical fields such as technology and industry.

- Develop analytical, visual, and spatial skills.

- Develop the skill of expressing two-dimensional and three-dimensional objects into professional language and vice versa.

- Acquire speed and accuracy in use of drawing instruments.

- Acquire the ability to readily draw neat sketches, often needed in "On-job situations".

- Use digital technology (CAD) in designing and developing isometric and orthographic projections of simple objects.

COURSE STRUCTURE

CLASS XI (2024-25)

One Paper (Theory): 3 Hours

70 Marks

One paper (Practical): 3 Hours

30 Marks

S. No.	Unit	Marks	Periods
I	PLANE GEOMETRY 1. Lines, angles, and rectilinear figures 2. Circles, inscribing and circumscribing of circles	10	25
II	SOLID GEOMETRY 3. Orthographic projection of points and lines 4. Orthographic projection of regular plane figures 5. Orthographic projection of right regular solids 6. Section of solids	30	99
III	MACHINE DRAWING 7. Orthographic projections of simple machine blocks 8. Isometric projection of laminae (plane figures)	30	50
Practicals		30	66
Total Marks		100	240

THEORY

I. PLANE GEOMETRY

25 Periods

**Printing English alphabets (capital and small) and numerals in standard proportions.
Unidirectional/aligned system of dimensioning as per SP 46:2003 (Revised)**

7 Periods

Unit 1: Construction of lines, angles, and their divisions. Simple questions based on triangles, square, rhombus, regular polygons-pentagon, and hexagon.

10 Periods

Unit 2: Construction of circles, inscribing and circumscribing of circles in equilateral triangle, square, rhombus, regular polygons-pentagon, and hexagon.

8 Periods

II. SOLID GEOMETRY

99 Periods

Unit 3: Orthographic projection: dimensioning and conventions strictly as per SP 46:2003 (Revised). Orthographic projection of points and lines.

25 Periods

- Unit 4: Orthographic projection of regular plane figures - triangle, square, pentagon, hexagon, circle, and semi-circle. 15 Periods
- Unit 5: Orthographic projection of right regular solids such as cubes; prisms and pyramids (square, triangular, pentagonal, and hexagonal); cones; cylinders; spheres; hemi-spheres; frustum of pyramids and cone, when they are kept with their axis (a) perpendicular to HP/VP (b) parallel to HP and VP both. 35 Periods
- Unit 6: Section of right regular solids such as cubes; prisms and pyramids (square, triangular, pentagonal, and hexagonal); cones; cylinders; spheres, kept with their axis perpendicular to HP/VP, made by a vertical cutting plane. 24 Periods

III. MACHINE DRAWING

50 Periods

- Unit 7: Orthographic projection of simple machine blocks. 25 Periods
- Unit 8: Isometric Projection - Construction of isometric scale showing main divisions of 10 mm and smaller divisions of 1 mm each. Isometric projection (drawn to isometric scale) of regular plane figures - triangle, square, pentagon, hexagon, circle, and semi-circle with their surface parallel to HP or VP (keeping one side either parallel or perpendicular to HP/VP). 25 Periods

PRACTICALS

66 Periods

1. Making different types of graphic designs/ murals for interior/ exterior decorations in colour using the knowledge of geometrical figures or 3D solids with the use of any Computer Software such as CollabCAD or any equivalent pertinent software.
2. Drawing the following engineering curve through activities - ellipse (by trammel & thread method) on the ground/ drawing sheet/ plywood/ cardboard etc.
3. Developing the following solids with the help of cardboard/ thick paper.
 - a) cube, cuboid
 - b) prisms & pyramids (triangular, square, pentagonal, and hexagonal)
 - c) right circular cylinder and cone
4. Preparing the section of solids (prisms, pyramids, sphere, etc.) with clay, soap-cake, plasticine, wax or with the 3D printing technology. When the cutting plane is: parallel to the base, perpendicular to the base or inclined to the base.
5. Preparing the top-view (plan) of a class-room/lab, home (Drawing Room/Bedroom/ Study Room, Kitchen) drawing different objects therein.

Note:

- I. 15 practical (minimum three each from aforementioned five points) are to be assessed.
- II. In all the practicals, drawing/sketching of the views should be incorporated and evaluated accordingly.
- III. The scheme of evaluation is as follows:

(a)	Practicals (2)	15 Marks
(b)	Drawing/ Sketch	05 Marks
(c)	Viva-voce	05 Marks
(d)	Sessional Work	05 Marks
Total		30 Marks

ACTIVITY

Industrial Visits (Two) to any industry/manufacturing plant to acquaint the students with the present - day methods & technology for better conceptual understanding.

COURSE STRUCTURE CLASS XII (2024-25)

One Paper (Theory): 3 Hours

70 Marks

One paper (Practical): 3 Hours

30 Marks

S. No.	Unit Name	Marks	Periods
I	Isometric Projections of Solids	25	60
II	Machine Drawing A. Drawing of Machine parts B. Assembly Drawing and Dis-assembly drawings 1. Bearings 2. Rod joints 3. Tie-rod and Pipe joint	45	114
Practical		30	66
Total Marks		100	240

THEORY

Unit I: Isometric Projection of Solids

60 Periods

- (i) Construction of isometric scale showing main divisions of 10mm and smaller divisions of 1 mm, also showing the leading angles. Drawing helping view/s such as triangles, pentagon, hexagon, etc., using isometric scale.
- (ii) Isometric projection (drawn to isometric scale) of solids such as cube; regular prisms and pyramids (triangular, square, pentagonal, and hexagonal); cone; cylinder; sphere; hemisphere. The axis and the base side of the solid should be either perpendicular to HP / VP or parallel to HP and VP.

- (iii) Combination of any two above mentioned solids keeping the base side parallel or perpendicular to HP/VP and placed centrally together (Axis of both the solids should not be given parallel to HP).

Note:

1. Hidden lines are not required in isometric projection.
2. Indicate the direction of viewing.

Unit II: Machine Drawing (as per SP46: 2003)

114 Periods

A. Drawing of machine parts

- (i) Drawing to full size scale with instruments. 30 Periods

(Internal choice will be given between any two of the following).

Introduction of threads: Standard profiles of screw threads - Square, Knuckle, B.S.W., Metric (external and internal); Bolts – Square head, hexagonal head; Nuts – Square head, Hexagonal head; Plain washer, Combination of nut and bolt with or without washer for assembling two parts together.

- (ii) Free-hand sketches 10 Periods

Conventional representation of external and internal threads; Types of studs – Plain stud, Square-neck stud, Collar stud; Screws (round-head, cheese-head, 90° flat counter sunk-head, hexagonal socket head and grub-screw); Types of rivets – Snap head, Pan head (without tapered neck), Flat head, 60° countersunk flat head.

B. Assembly drawings and Dis-Assembly drawings

(Internal choice will be given between an Assembly drawing and a Dis-Assembly drawing). 74 Periods

1. Bearings
 - (i) Open-Bearing
 - (ii) Bush- Bearing
2. Rod-Joints
 - (i) Cotter-joints for round-rods (Sleeve and cotter joint)
 - (ii) Cotter-joints for square rods (Gib and cotter-joint)
3. Tie-rod and Pipe-joint
 - (i) Turnbuckle
 - (ii) Flange pipe joint

Note:

1. *In all Assembly drawings, half sectional front view will be asked. Side/End view or Top View/Plan will be drawn without section.*

2. *In all Dis-assembly drawings, only two orthographic views (one of the two views may be half in section or full in section) will be asked of any two parts only.*
3. *(a) In all sectional views, hidden lines/ edges are not to be shown.*
(b) In all full views, hidden lines/edges are to be shown.

PRACTICALS

66 Periods

(i) To perform the following tasks (for One only) from the given views of the prescribed fifteen (15) machine blocks in **ANNEXURE-I**.

Value-Points

- | | |
|---|----|
| 1. Copy the given views | 1 |
| 2. Drawing the missing view with hidden lines | 2 |
| 3. Sketching the Isometric view without hidden edges | 5 |
| 4. To make the machine block of the above in three dimensions.
(Not to scale but approximately proportionately drawn with
Any medium i.e., Soap-cake, plasticine, clay, wax, floral foam brick
(available with florists), etc. | 7 |
| (ii) Computer Aided Design (CAD) – Project | 10 |
| Project file to be submitted on the simple solids or machine blocks as prescribed in part-I by using the CollabCAD software or any equivalent pertinent software. | |
| (iii) (a) Sessional work relating to machine blocks as prescribed. | 3 |
| (b) Viva-voce based on part-I and part-II | 2 |

Total Marks 30

ACTIVITY

Industrial Visits (Two) to any industry/ manufacturing plant to acquaint the students with the present - day methods & technology for better conceptual understanding.

ANNEXURE -- 1

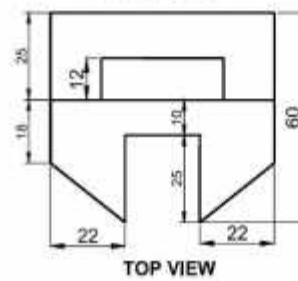
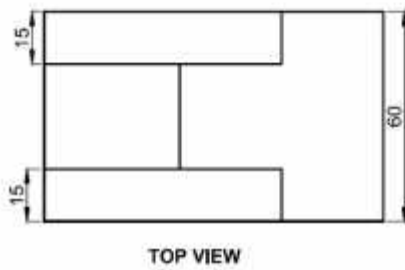
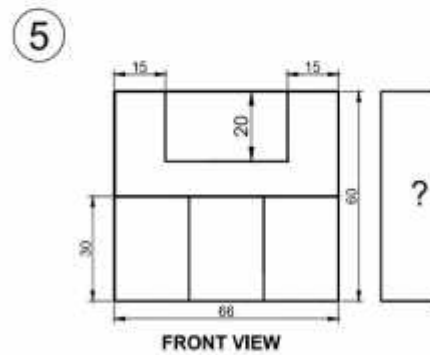
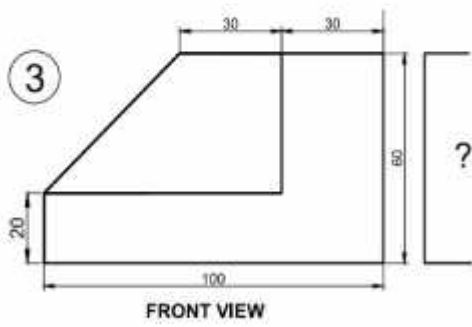
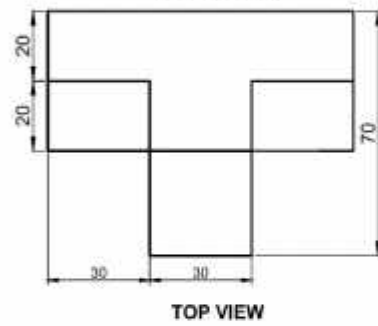
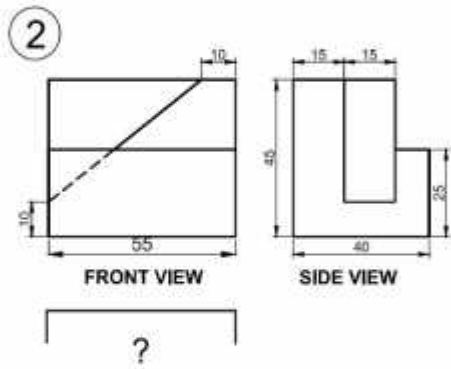
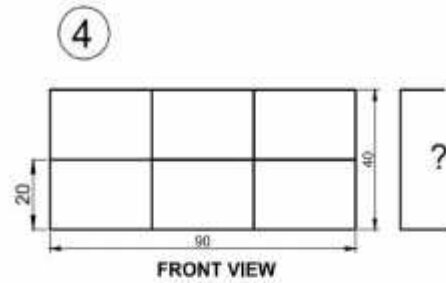
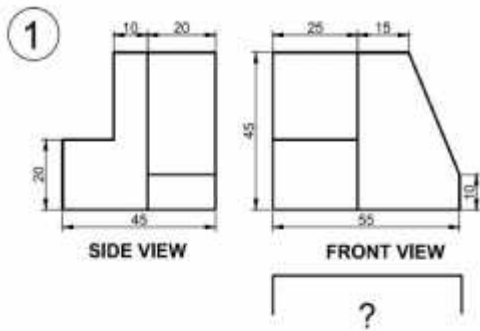

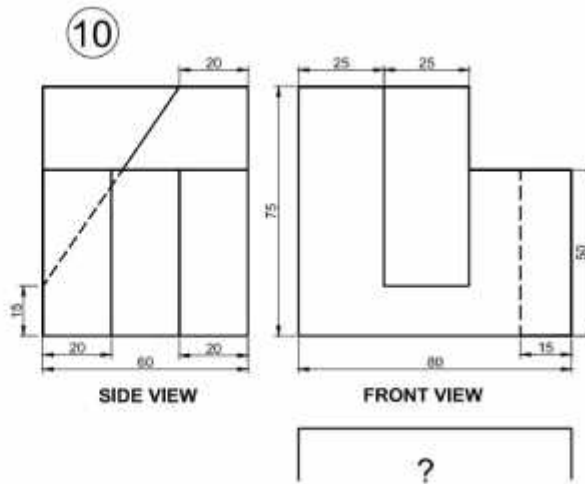
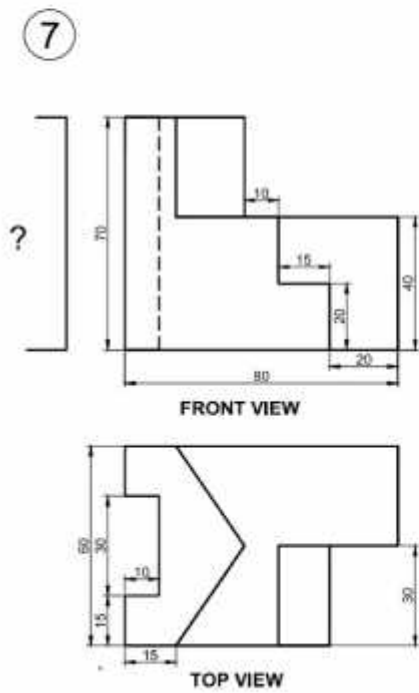
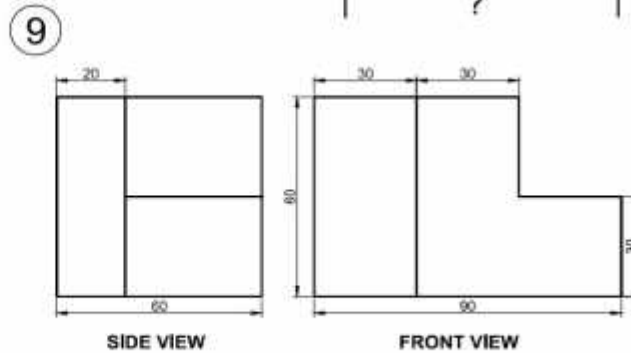
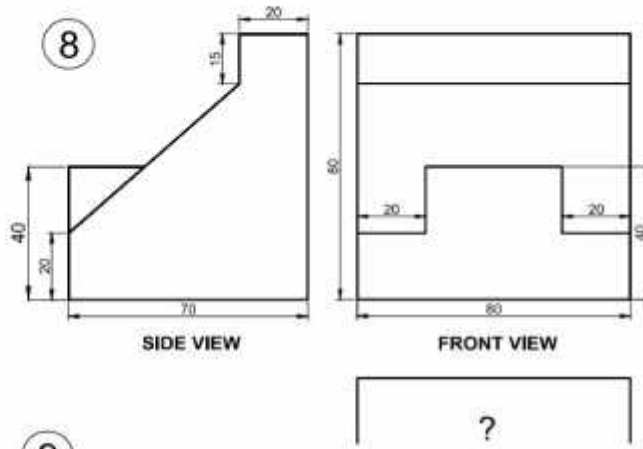
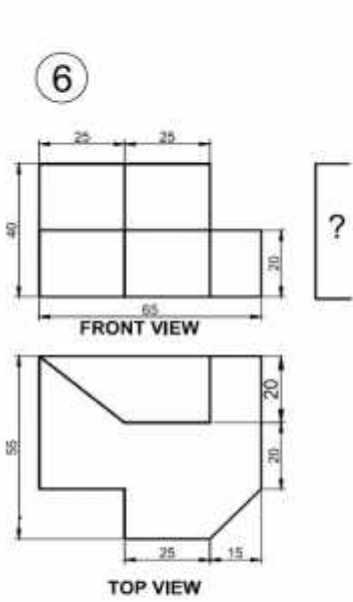

11

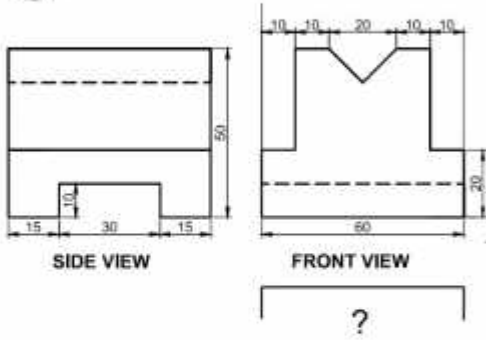

13

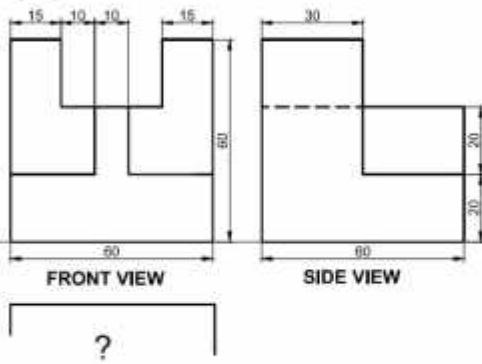

12

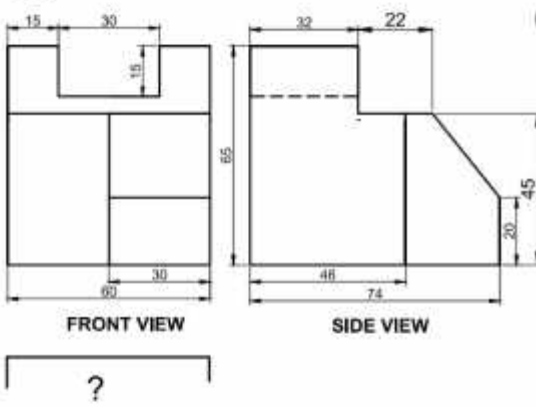

14

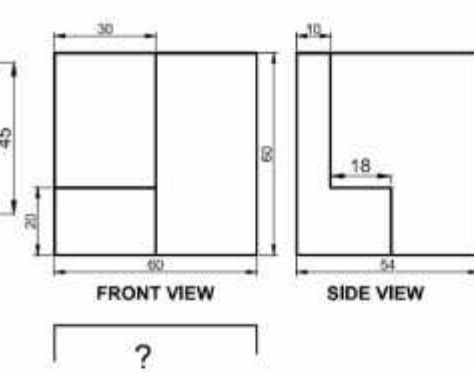

15

