

VIDEO COURSES

for Government Exams



From the oldest and most trusted name in Exam Preparation which gave us Career Power, Bankersadda, Sscadda, here is the latest offering – Video Courses that are tailor-made for the Govt. Job aspirants of digital India. Various banking and SSC exams are conducted online with regular changes to exam pattern and level of questions. We understand the changing needs of the students and have devised a unique solution, making preparation easy, cost-effective and efficient.

Video courses for banking and SSC consist of exhaustive video lectures for government exams which are pre-loaded on an SD card. We offer these courses in two variants: [Android Tab + SD-Card] or [SD Card only]. The SD Card can be run on your personal android device as well. The video courses will run on the Adda247 mobile app, the number one App for Bank and SSC exam preparation.

What you get?

VIDEO COURSE

Video Courses are available in:

- 32 GB Micro SD Card
- Android Tablet (SD Card included)

Available Courses

Bank	SSC	SSC	SSC
Banking Complete Video Course	Maths Video Course for SSC Exams	Maths + English Video Course for SSC Exams	SSC Complete Video Course

To Purchase visit : elearning.adda247.com

For any query : Call us at +91-90691 42412 • Email us at elearning@adda247.com

Solutions

Solutions (1-5):

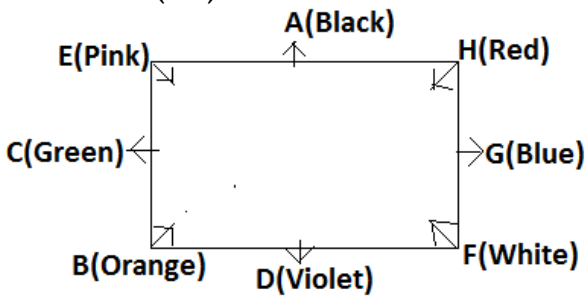

S1. Ans.(a)

S2. Ans.(e)

S3. Ans.(c)

S4. Ans.(a)

S5. Ans.(b)

S6. Ans.(a)

Sol. F is opposite to A.

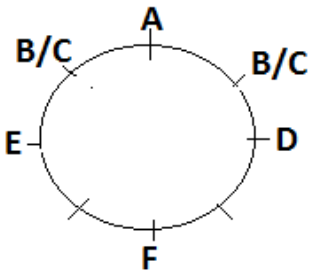

S7. Ans.(e)

Sol. From statements I- $D > G, J, F > E$

From statement II- either $J > H > F > G > E$ or $J > G > F > H > E$

From statement I and II both- $D > J > H > F > G > E$ or $D > J > G > F > H > E$

Hence D got maximum marks.

S8. Ans.(e)

Sol. From both 1 and 2-

We can say that Y and Z are on the extreme end of the line.

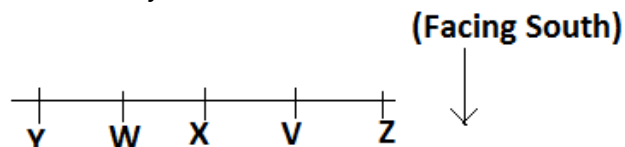

S9. Ans.(d)

Sol. Because gender of S is not define so I and II together are not sufficient to answer.

SSC CGL TIER II

Maths & English

@ 399/-

Mock Test Booklets

10 TEST BOOKLETS (PRINTED TEST)

Bilingual

S10. Ans.(b)

Sol. By statement II-

S > T > P > R > Q

Solutions (1-5):

Students let us understand the Logic behind this Question and let's understand how to solve it. When we see the each step, then we can find that there is both number and words are arranged in each step.

1) For words arrangement- Words are arranged in ascending order according to last letter of each word. The letter which is lowest arranged first to left. And this process is continued in further step.

2) For number arrangement- Number are arranged according to multiplication of digits of each number. The multiplication value which is lowest arranged first to left. This process is continued in further step.

Input: three 39 year 45 action 26 agenda 51 is 71

Step I: 51 agenda three 39 year 45 action 26 is 71

Step II: 71 three 51 agenda 39 year 45 action 26 is

Step III: 26 action 71 three 51 agenda 39 year 45 is

Step IV: 45 year 26 action 71 three 51 agenda 39 is

Step V: 39 is 45 year 26 action 71 three 51 agenda

S11. Ans.(c)

S12. Ans.(a)

S13. Ans.(c)

Sol. Five

S14. Ans.(a)

S15. Ans.(e)

Solutions (16-20):

HAVE ————— BV@4

(Reverse of last letter)
|
(Total number of letter)
|
(If total number of letter in a word is even number then use@ symbol
|
(Immediate otherwise #)
succeeding of second letter in a word)

S16. Ans.(d)

S17. Ans.(e)

S18. Ans.(a)

S19. Ans.(c)

S20. Ans.(d)



Solutions (21-25):

- 7— S(Meerut)
- 6— Q(agra)
- 5— V(Puri)
- 4— P(Delhi)
- 3— U(Kanpur)
- 2— T(Pune)
- 1— R(Noida)

- S21. Ans.(a)
- S22. Ans.(b)
- S23. Ans.(e)
- S24. Ans.(e)
- S25. Ans.(b)

Solutions (26-30):

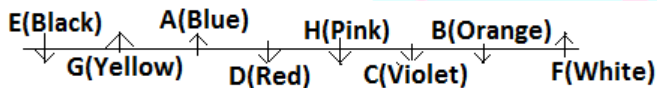

- S26. Ans.(d)
Sol. blue
- S27. Ans.(c)
Sol. three
- S28. Ans.(d)
- S29. Ans.(c)
- S30. Ans.(e)

S31. Ans.(b)

Sol. Argument I is weak because it does not provide sufficient reason.
Argument II is strong because it is true.

S32. Ans.(d)

Sol. Argument I is weak as it is vague.
Argument II is also weak because it is not true.



IBPS SPECIAL COMBO 2017

with Video Solutions

360 TOTAL TESTS

- 150 Full Length Mocks
- 210 Practice Sets
- E-Books, Study Notes etc.

Bilingual



S33. Ans.(d)

Sol. Argument I is weak as it is vague.

Argument II is also weak because it is not true.

S34. Ans.(c)

Sol. From the given two statements I and II, it is clear that each statement is self-sufficient in itself and are independent causes.

Therefore, both the statement I and II are independent causes.

S35. Ans.(b)

Sol. From the given two statements I and II, it is clear that an increase in number of asthma cases led the authorities to take action to control air pollution that triggers the disease.

Therefore, statement II is the cause and statement I is its effect.

Solutions (36-38):

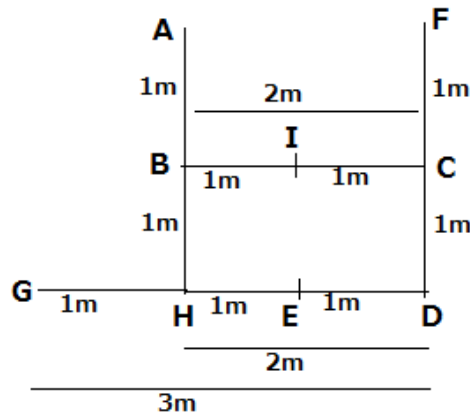

S36. Ans.(c)

S37. Ans.(a)

S38. Ans.(e)

S39. Ans.(b)

Sol. R is the mother of T.

S40. Ans.(d)

Sol.

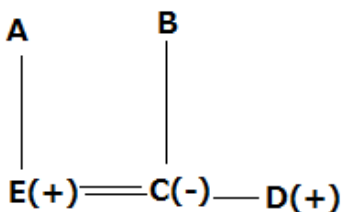

CAREER POWER
AN IIT/IIM ALUMNI COMPANY

IBPS **IBPS CLERK**
MAINS

with Video Solutions

40 TOTAL TESTS

- 15 Full Length Mocks
- 25 Practice Sets
- E-Books, Study Notes etc.

Bilingual

Solutions (41-45):

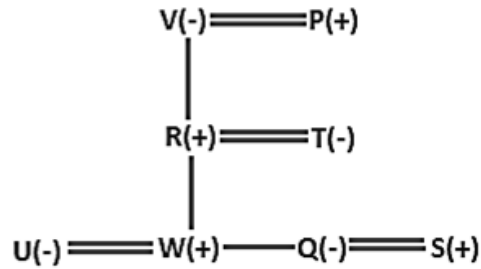
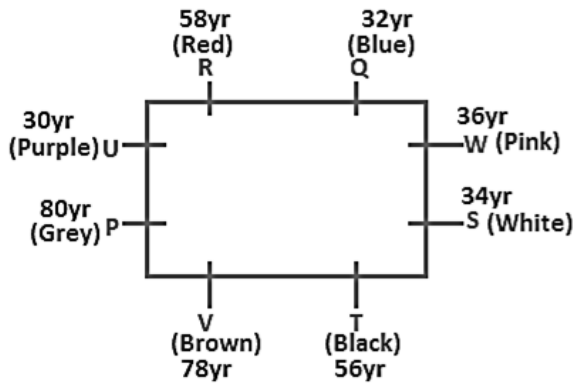

- S41. Ans.(e)
- S42. Ans.(b)
- S43. Ans.(e)
- S44. Ans.(d)
- S45. Ans.(e)

Solutions (46-50):

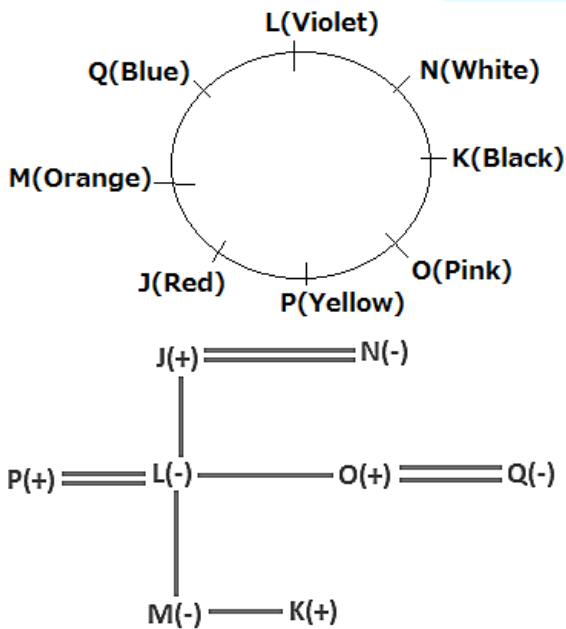

- S46. Ans.(c)
- S47. Ans.(d)
- S48. Ans.(d)
- S49. Ans.(d)
- S50. Ans.(d)



CAREER POWER
 AN IIT/IIM ALUMNI COMPANY

RBI OFFICE ATTENDANT
 All India Mock 2017

USE CODE: RBIA17
 for 100% discount



VIDEO COURSE

Compliment your classroom with Banking Video Courses
visit: videocourses.adda247.com

Study on the GO with the Adda247 App

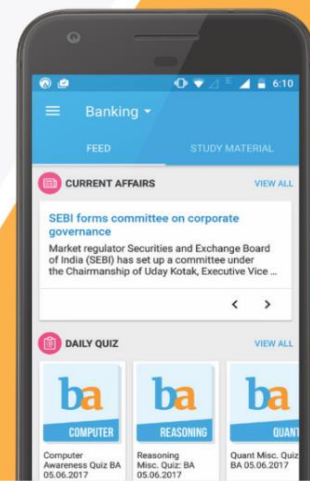

Boost your prep with Topic-wise E-books and monthly Magazines
visit: store.adda247.com



Fulfill your Dream of **Government Job** visit: careerpower.in